

# Designer Collection Shower Bases



## MTSB-7236MT

71.875" x 36" x 3"

### GENERAL SPECIFICATIONS

Material - Acrylic  
 Shipping Weight - 175 lbs / 79 kg  
 Threshold - Multiple, Low-Profile  
 Drain Location - Center  
 Flooring - Smooth

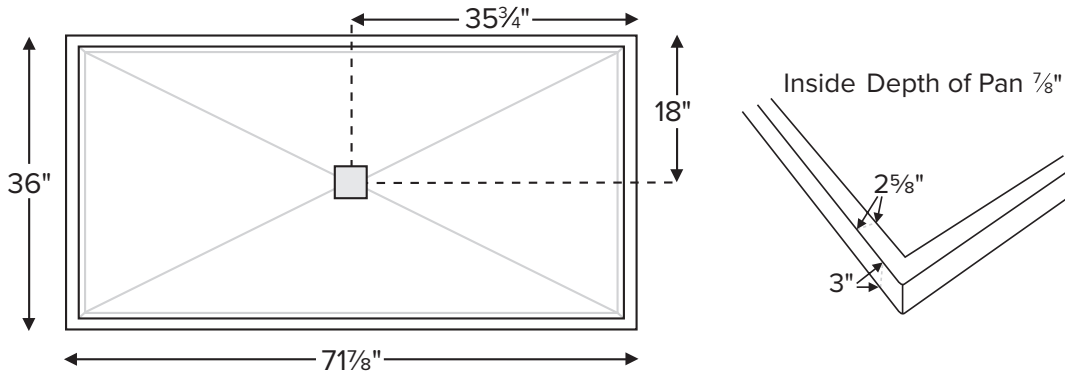

When ordering, please specify tile flange locations.

Model #	Size	Shape	MSRP
SB7236MT	71.875" x 36" x 3"	Rectangle	<b>\$2,130</b>

Options <i>Must be ordered at time of purchase</i>
<b>Color</b> Please specify color on order White (CWH) Biscuit (CBS)
<b>Finish Option</b> shower base comes standard in gloss finish <b>Matte Finish Upcharge (SBMATTE) \$105</b> (white only)
<b>Quick Ship (QSPRI) \$400</b> Reduces lead time. Please call for availability.
<b>Radiance® (RAD100) \$1,470</b> Shower floor heating system. Radiance heating grids are fully integrated within the acrylic shell structure of the shower floor. Requires a 110-volt, 15 amp GFCI and remote installation of control box & keypad.
<b>Pre-Levelled Foam Base (PLFSB) \$170</b>
<b>PVC Drain Kit Finishes</b> Chrome included with shower base Brushed Nickel upcharge (SBSQDBN) <b>\$65</b> Special Finishes upcharge* (SBSQDSF) <b>\$310</b> *Must send finish sample and allow 3-4 weeks additional lead time.

Accessories
<b>Drain Kit Options</b> Solid Brass Drain Kit with Stainless Steel Cover (SBSQDSB) <b>\$195</b>
<b>Teak Shower Seat</b> Premium Natural Stainless (TK-SSEAT2416BNS) <b>\$2,755</b> High-Polished Stainless (TK-SSEAT2416BHP) <b>\$3,150</b> Standard Natural Stainless (TK-SSEAT2215NS) <b>\$1,020</b> High-Polished Stainless (TK-SSEAT2215HP) <b>\$1,430</b>
<b>Teak Bath Mat (TKMAT3018) \$740</b> Measures 30" x 17.5" x 1" Custom sizes also available. Contact MTI for details.
<b>Teak Shower Tray (TK7236MT) Contact MTI for pricing</b>

### IMPORTANT ORDERING & INSTALLATION INFORMATION

- Factory-installed tile flange on 1, 2 or 3 sides to facilitate installation. Must specify tile flange location(s) on order.
- 3.5" drain opening pre-drilled.
- Drain finish options on this sheet are upcharge prices only. Contact MTI for ordering details for drain kits sold separately.
- Compliant with ASTM C 1028-07 coefficient of friction test.
- Add proper wet-bedding compound to fully support bottom of shower base. Optional factory installed Pre-Levelled Foam Base negates the need to wet bed when installing on a flat, level subfloor. See installation instructions.

• Options and accessories may be packaged inside the tub crate. Always check packaging before discarding.  
 • All product measurements are ±1/2".  
 • Specifications and configurations are subject to change without notice.  
 • Measurements herein supersede all others published prior to publication date below.

See the Installation & Operation Manual for more details.  
 MTI's Customer Service: Monday-Friday 8am-6pm EST  
**800-783-8827** or [service@mtibaths.com](mailto:service@mtibaths.com)

CSA # MTSB-7236MT

©2021 by MTI Baths, Inc. Modification Rights Reserved



Rev. 08 12 2021