

Designer Collection Shower Bases

MTSB-3636MT

36" x 36" x 3"

GENERAL SPECIFICATIONS

Material - Acrylic
 Shipping Weight - 65 lbs / 29 kg
 Threshold - Multiple, Low-Profile
 Drain Location - Center
 Flooring - Smooth

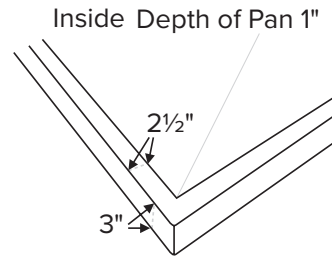
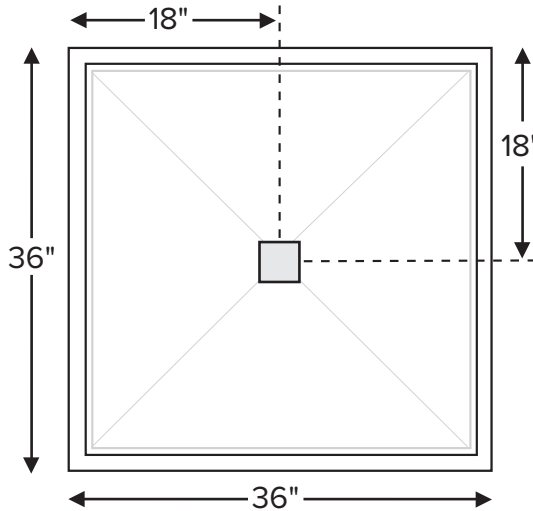

When ordering, please specify tile flange locations.

Model #	Size	Shape	MSRP
SB3636MT	36" x 36" x 3"	Rectangle	\$1,535

Options <i>Must be ordered at time of purchase</i>
Color Please specify color on order White (CWH) Biscuit (CBS)
Finish Option shower base comes standard in gloss finish Matte Finish Upcharge (SBMATTE) \$105 (white only)
Quick Ship (QSPRI) \$400 Reduces lead time. Please call for availability.
Radiance® (RAD100) \$1,470 Shower floor heating system. Radiance heating grids are fully integrated within the acrylic shell structure of the shower floor. Requires a 110-volt, 15 amp GFCI and remote installation of control box & keypad.
Pre-Levelled Foam Base (PLFSB) \$170
PVC Drain Kit Finishes Chrome included with shower base Brushed Nickel upcharge (SBSQDBN) \$65 Special Finishes upcharge* (SBSQDSF) \$310 *Must send finish sample and allow 3-4 weeks additional lead time.

Accessories
Drain Kit Options Solid Brass Drain Kit with Stainless Steel Cover (SBSQDSB) \$195
Teak Shower Seat Premium Natural Stainless (TK-SSEAT2416BNS) \$2,755 High-Polished Stainless (TK-SSEAT2416BHP) \$3,150 Standard Natural Stainless (TK-SSEAT2215NS) \$1,020 High-Polished Stainless (TK-SSEAT2215HP) \$1,430
Teak Bath Mat (TKMAT3018) \$740 Measures 30" x 17.5" x 1" Custom sizes also available. Contact MTI for details.
Teak Shower Tray (TK3636MT) Contact MTI for pricing

IMPORTANT ORDERING & INSTALLATION INFORMATION

- Factory-installed tile flange on 1, 2 or 3 sides to facilitate installation. Must specify tile flange location(s) on order.
- 3.5" drain opening pre-drilled.
- Drain finish options on this sheet are upcharge prices only. Contact MTI for ordering details for drain kits sold separately.
- Compliant with ASTM C 1028-07 coefficient of friction test.
- Add proper wet-bedding compound to fully support bottom of shower base. Optional factory installed Pre-Levelled Foam Base negates the need to wet bed when installing on a flat, level subfloor. See installation instructions.

• Options and accessories may be packaged inside the tub crate. Always check packaging before discarding.
 • All product measurements are ±1/2".
 • Specifications and configurations are subject to change without notice.
 • Measurements herein supersede all others published prior to publication date below.

See the Installation & Operation Manual for more details.
 MTI's Customer Service: Monday-Friday 8am-6pm EST
800-783-8827 or service@mtibaths.com

CSA # MTSB-3636MT

©2021 by MTI Baths, Inc. Modification Rights Reserved



Rev. 08 12 2021